

This article was downloaded by: [Stephen Chesters]

On: 13 November 2014, At: 04:18

Publisher: Taylor & Francis

Informa Ltd Registered in England and Wales Registered Number: 1072954 Registered office: Mortimer House, 37-41 Mortimer Street, London W1T 3JH, UK

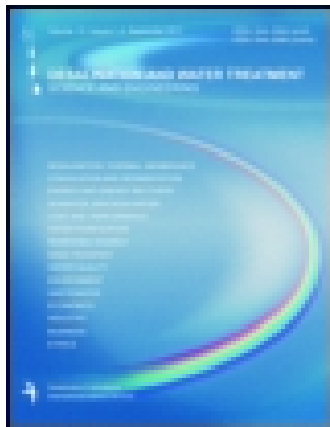

Desalination and Water Treatment

Publication details, including instructions for authors and subscription information:

<http://www.tandfonline.com/loi/tdwt20>

Microbubble RO membrane cleaning reduces fouling on WWRO plant

Stephen P. Chesters^a, Matthew W. Armstrong^a & Maqsood Fazel^a

^a Genesys International Ltd, 3A Aston Way, Middlewich CW10 0HS, UK, Tel. +004 413 72 741 881

Published online: 19 Aug 2014.

To cite this article: Stephen P. Chesters, Matthew W. Armstrong & Maqsood Fazel (2014): Microbubble RO membrane cleaning reduces fouling on WWRO plant, Desalination and Water Treatment, DOI: [10.1080/19443994.2014.940225](https://doi.org/10.1080/19443994.2014.940225)

To link to this article: <http://dx.doi.org/10.1080/19443994.2014.940225>

PLEASE SCROLL DOWN FOR ARTICLE

Taylor & Francis makes every effort to ensure the accuracy of all the information (the "Content") contained in the publications on our platform. However, Taylor & Francis, our agents, and our licensors make no representations or warranties whatsoever as to the accuracy, completeness, or suitability for any purpose of the Content. Any opinions and views expressed in this publication are the opinions and views of the authors, and are not the views of or endorsed by Taylor & Francis. The accuracy of the Content should not be relied upon and should be independently verified with primary sources of information. Taylor and Francis shall not be liable for any losses, actions, claims, proceedings, demands, costs, expenses, damages, and other liabilities whatsoever or howsoever caused arising directly or indirectly in connection with, in relation to or arising out of the use of the Content.

This article may be used for research, teaching, and private study purposes. Any substantial or systematic reproduction, redistribution, reselling, loan, sub-licensing, systematic supply, or distribution in any form to anyone is expressly forbidden. Terms & Conditions of access and use can be found at <http://www.tandfonline.com/page/terms-and-conditions>



Microbubble RO membrane cleaning reduces fouling on WWRO plant

Stephen P. Chesters*, Matthew W. Armstrong, Maqsood Fazel

Genesys International Ltd, 3A Aston Way, Middlewich CW10 0HS, UK, Tel. +004 413 72 741 881; email: schesters@genesysro.com (S.P. Chesters)

Received 1 April 2014; Accepted 15 June 2014

ABSTRACT

Over the last 10 years, there have been significant developments in new devices for energy recovery, new membrane materials and new sizes and orientations of reverse osmosis (RO) plants, all designed to reduce costs and improve efficiency. The fundamental issue of keeping membrane surfaces clean to ensure efficient RO plant operation has seen relatively few recent developments. This is surprising as any fouling of the membrane surface will have a dramatic effect on energy consumption and plant efficiency. Many researchers have focused on identifying and studying the foulants in great detail, but there have been few studies in how to remove it. Commodity acid and alkali compounds are still widely used due to the perceived lower application costs. Specially blended cleaning chemicals incorporating detergents, surfactants and chelants are also in wide use and are increasingly accepted by the market to be economically and environmentally viable. “Strategically pairing chemical agents that have complementary cleaning mechanisms so a higher cleaning efficiency can be attained” has been described by Wui. The authors have established a research project to explore in detail the use of novel physical and chemical cleaning methods. These included effervescent chemicals, physically generated bubbles and high ionic strength cleaners designed to agitate the cake layer on the membrane surface, assisting deposit removal. A series of experiments using flat sheet test rigs and pilot plant have been completed and the results presented in papers at IDA Tianjin 2013. This paper explains how the multiple cleaning mechanisms remove foulants and presents new data from a food processing plant which recycles wastewater through an RO plant is presented. Historically, cleans were conducted every one to two weeks due to the very high fouling rate. An air inductor and specially formulated cleaning compound cleaners A & B incorporating effervescent and high ionic strength demonstrated that the plant could be cleaned more efficiently and in a shorter timescale than using conventional cleaners. The presence of microbubbles has a dramatic effect on cleaning efficiency as a result of agitation of deposits on the membrane surface. The differential pressure of the first-stage plant was reduced for 4.5 bar to consistently less than 1 bar. The quantity of permeate produced increased from 15 to 24 m³/h. The underlying fouling rate was dramatically reduced so cleans are now conducted on a 6–8 week cycle rather than a 10-day cycle. These improvements occurred because cleaning using microbubbles has been more effective and the membrane surface much cleaner than previously. A

*Corresponding author.

*Presented at the Conference on Desalination for the Environment: Clean Water and Energy
11–15 May 2014, Limassol, Cyprus*

1944-3994/1944-3986 © 2014 Balaban Desalination Publications. All rights reserved.

clean membrane surface does not foul as quickly as a dirty membrane surface due to surface roughness. The potential for enhanced membrane cleaning by combining different chemical and physical mechanisms is an exciting area of research.

Keywords: RO membrane cleaning; Microbubbles; Air sparging; Antiscalant; Fouling removal; Innovations; Chemical cleaning

1. Introduction

The use of products formulated with multiple cleaning mechanisms offers enhanced cleaning performance. "Strategically pairing chemical agents that have complementary cleaning mechanisms so a higher cleaning efficiency can be attained" has been described by Ang et al. [1]. Conducting an effective clean rather than multiple partial cleans is a gentler and more efficient process to help extend membrane lifespan and reduce operational costs. The authors have formulated membrane cleaners A (acidic) & B (alkaline) which incorporate effervescent reagents that produce very small mini, midi and microbubbles which agitate deposits at the membrane surface assisting their removal. The new cleaners are powder high ionic strength compounds which, when used during an off-line clean causes normal osmosis to occur during periods of soaking. Permeate water passes through the membrane surface to the feed-side breaking up layered deposits. This allows the cleaning chemicals improved penetration to dislodge deposits. These powdered products have proven particularly effective against clay, biofilm and organic removal which make up 85% of the foulants in lead elements. The amount of generated microbubbles is further increased using a specially designed microbubble generator which inducts air into the cleaning solution being circulated through the reverse osmosis (RO) plant. If a pump forces a fluid flowing into the microbubble generator tube an increase in velocity occurs in the constricted part simultaneously with the decrease in pressure which leads to air being sucked in through the tube. Pressure recovery takes place further downstream and the air drawn in collapses forming bubbles which then have a tendency to coalesce into larger bubbles around the microbubble generator. In order to optimise cleaning, it is preferable to have micro- and macro-sized bubbles. The authors discovered that using specially formulated cleaning agents (cleaner A or B) the coalescing of micro, mini and midibubbles into larger bubbles can be minimised. The cleaning reagents create a suspension of bubbles and cleaning solution which distributes evenly over the membrane surface in a pulsed fashion giving an enhanced cleaning effect. Extensive lab-scale experiments utilising cleaners A &

B with air have been carried out over 18 months using a flat sheet test rig with polycarbonate viewing window. Cleans were then carried out on full 8" spiral wound polyamide membrane elements in a single and triple element pressure vessel RO pilot plant. These lab and pilot plant results indicated promising results. Flux rates were improved when compared with using conventional and commodity cleaners and subsequent autopsies confirmed improved cleanliness. Autopsies on virgin membranes subjected to cleaning using cleaner A or B and inducted air confirmed that there was no damage to the polyamide layer. This laboratory and pilot plant work was published in papers presented at IDA Tianjin 2013 [2,3,4]. This paper presents the results of membrane cleans using multiple cleaning mechanisms and microbubbles conducted on a wastewater treatment RO plant at a salad washing factory in the UK which had a very high fouling rate.

2. Cleaning mechanisms

The use of microbubbles, effervescent and high ionic strength cleaners tested in our research facility has resulted in enhanced cleaning of membranes. This is due to increased agitation of deposits on the membrane surface by the combined effect of different chemical and physical mechanisms. These mechanisms can be summarised as follows.

2.1. Microbubble cleaning

Agitation of deposits at the membrane surface using a high concentration and wide distribution of bubble sizes which are well known for cleaning a variety of deposits in different industries. The cleaning effect occurs "when bubbles expand and collapse close to boundaries, a shear flow is generated which is able to remove particles from the surface, thus locally cleaning it" [5]. This phenomenon has been tested by numerous researchers notably Agarwal et al. "investigated the potential of air microbubbles for biofilm detachment from a nylon membrane surface in comparison to chemical cleaning by sodium hypochlorite (NaOCl). About 88% of fixed biomass detachment was observed after 1 h air microbubbling, while only 10% of biofilm detachment was achieved in the control experiment without microbubbles [6]. Compressed, injected air

[7,8] is used in cleaning and backwashing membrane bioreactors, microfiltration and ultrafiltration membranes but has not been applied successfully to RO membrane elements. The 2- μm polyamide surface of an RO membrane is at a molecular level and very easily damaged by scouring and use of compressed air and so air scouring has traditionally not been used on RO or NF membranes. Research by Willems into using a single-source compressed air as a possible method of increasing RO membrane efficiency noted considerable drawbacks due to problems associated with velocity of the introduced bubbles, too low and resultant stagnant bubbles blocked flow through the membrane, too high and the bubbles passed straight from inlet to outlet. Both effects reduce the area coverage of the bubbles [9]. Experiments have shown that when cleaning tests are performed using only air and water with the microbubble generator, the bubbles produced are large (Fig. 1) and inconsistent. The use of commodity chemicals did not reduce the bubble size. Using specially formulated cleaners A & B in combination with the microbubble generator produced much smaller and more refined bubbles (Fig. 2).

When pictured on the membrane flat sheet test rig, the air bubbles with water and commodity caustic chemicals tend to become lodged in the feed spacer diamond shape around 1–2 mm in size. This reduces contact between the cleaning solution and the membrane, and spacer surfaces, thus reducing the chemical affect the cleaning solution could have. The bubble size was measured using an endoscope and is shown in Fig. 3. Using the specially formulated cleaning reagents, A or B created a suspension of very small bubbles and cleaning solution which was distributed

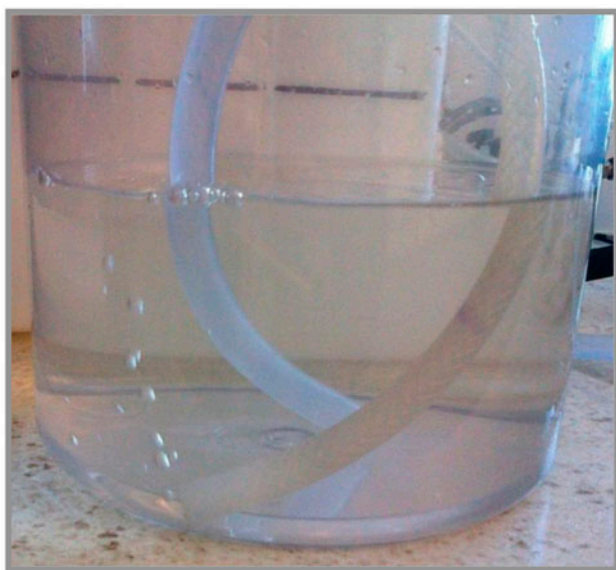

Fig. 1. Large bubbles created with air and water.

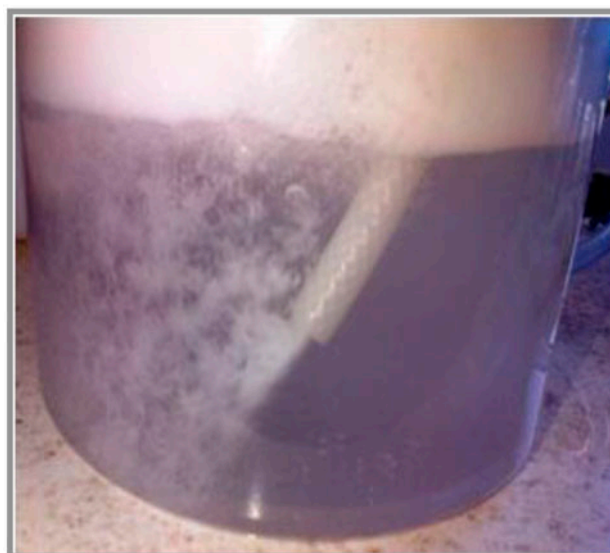

Fig. 2. Small refined bubbles with air and cleaner A.

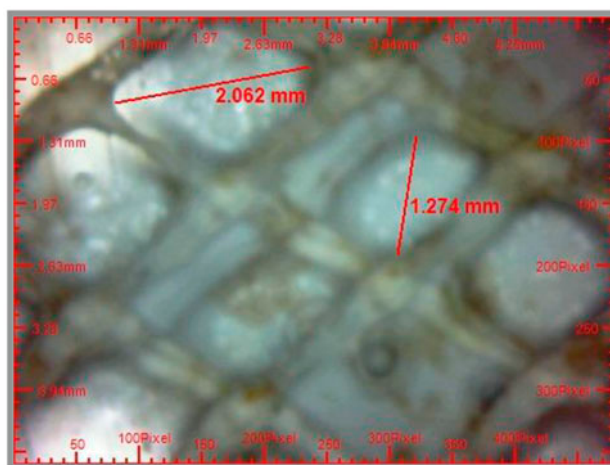

Fig. 3. NaOH cleaning solution and air creates large bubbles stuck in feed spacer.

evenly over the membrane surface in a pulsed fashion. This phenomenon alleviated the problems discovered by Willems et al. who could not get even distribution of bubbles across the membrane surface [9]. This created a more turbulent cleaning solution, agitating the foulant on the membrane surface for ease of removal. The bubble sizes measured with the endoscope pictured on a flat sheet test rig were between 5 and 500 μm (Fig. 4).



Fig. 4. Cleaner A and air creates evenly distributed microbubbles.

2.2. Natural osmosis

During periods of soaking in the cleaning protocol, the high ionic strength of the cleaning solution causes movement of permeate across the membrane surface through natural osmosis. This low flow of permeate is sufficient to agitate and dislodge difficult-to-remove foulants in particular layers of biofilm or colloidal clay. This then enables the cleaning compounds to further break up, disrupt and remove fouling particles. This, in turn, would allow greater access to the surfactant cleaning chemicals to remove deposits. The removal of deposits away from the membrane into the concentrate stream is likely to help minimise membrane abrasion.

2.3. Effervescent reagents

When a powder-based formulated cleaner, including an effervescent reagent, is dissolved in permeate water to make up the cleaning solution, the effervescent reagents evolve gas as bubbles which physically agitate the foulant during cleaning circulation. This has a dual effect of physically removing the foulant and increasing surface area of the cleaning reagents to the foulant surface. The effervescent creates a wide distribution of mini, midi and microbubbles sizes from 5 to 500 μm .

2.4. Chemical

cleaning agents can remove deposits from the membrane surface through a number of reactions

notably: hydrolysis, peptisation, saponification, solubilisation, dispersion (suspension) and chelation. Cleaners A & B are specially formulated high and low pH-powdered cleaning reagents containing detergents, chelants, effervescent, surfactants and ionic strength builder. The high pH cleaner B is used to remove clay, biofilm and organics. Cleaner B mode of action can be described as follows: the first stage of attack occurs at the water/surface interphase of the clay deposit and is due to the synergistic mode of operation of the combined speciality chemicals. This process works by reducing the surface tension of the deposit allowing the surfactant to become more effective in overcoming the impermeability of the material; this allows the cleaning solution to penetrate to the interlayer space of the clay structure. The clay then becomes more porous increasing the permeability to water and consequently increasing the surface area of the deposit allowing more active chemical to penetrate and disrupt the "body" of the deposit. Cleaner B provides a secondary physical action which increases cleaning efficiency at the membrane surface allowing a "double edged" approach to deposit removal. This action removes blockages from the membrane pores caused by the swelling effect of the hydrated clay particles. Low pH is used to remove some mineral scales and metal deposits. The ratio of these reagents in the products is vital to the cleaning process as they incorporate multiple cleaning mechanisms. During our experiments, we found that the cleaning reagents A & B when used at a 1–2% solution in conjunction with the microbubble generator had a profound effect on the bubble size distribution and also imparted a pulsing phenomenon on the cleaning solution after exit from the physical generator device. An even distribution of the cleaning and microbubble suspension across the whole membrane surface was observed under the flat sheet test rig.

3. Case study

An RO plant having a history of rapid and consistent fouling was chosen to trial the new microbubble multi-mechanism RO membrane cleaning approach. The site is a major salads producer in the UK. The salad wash water is recycled and contains bacteria, soil and clay. All the factory process water is also recycled and is contaminated with bacteria and detergents and cleaners were used in the wash-down and factory cleaning-in-place systems. The wastewater treatment and reuse plant incorporates an advanced membrane bioreactor ultra-filtration and RO plant to treat and purify the water for reuse and discharge.

3.1. System description

The treatment plant is based on pre-treatment and aerated flow balancing followed by an advanced membrane bioreactor (AMBR), RO and ultraviolet (UV) disinfection. (Fig. 5) A total of 1,400 m³/d of wastewater to be treated can be produced by the factory all of which is pumped to the AMBR. After RO and UV disinfection, up to 450 m³/d of treated water is fed to the incoming mains water tank for blending prior to entering the factory for salad washing and process water.

The plant treats an influent COD total to the balancing tank of up to 480 kg/d depending on factory production. In order to effectively separate biomass, three banks of ultra-filtration modules are used, fed by a recirculation system from a single bioreactor tank. An intensive aerobic environment is created in the AMBR using a JETOX aeration system allowing a high quality final effluent to be achieved in a small footprint.

3.2. System operation

The RO plant was commissioned in 2004 and has been prone to fouling under periods of peak production. The results of autopsies on membrane elements and cartridge filters indicated that foulant is mainly organic and microbiological in origin. There is also aluminium silicate present as clay and soil from the salad washing process and calcium phosphate

deposits. In 2006, there were three incidences of the plant tripping out on high pressure due to calcium phosphate scale formation. Membrane cleaning was conducted using a biocide followed by cleaner C and cleaner D. The biocide and cleaner C, an alkaline blend of detergent chelant and surfactant, were used to remove biofilm and clay. Cleaner D is a mild acidic cleaner which, when used at a pH of 3.0–3.5, is very effective at removing calcium phosphate scale. The high phosphate events were due to increased use of a phosphoric acid-based cleaning formulation by the hygiene department in the factory, which affected the phosphate balance in the feed water to the RO plant. Over the preceding years, better control of these incidents was achieved but there remains an underlying high fouling rate and a need to conduct cleans every 7–14 d as the pressure required to maintain water production continually increased. A basic programme of cleaning using Cleaner C and D has been implemented for seven years. The frequency of cleaning resulted in membrane elements being changed every 18–24 months. In 2013, two new effervescent products with high ionic strength were introduced—Cleaner A mildly acidic and cleaner B alkaline. From October 2013, only cleaner B and inducted air to create micro-bubbles was used.

3.3. Cleaning products

The following cleaning products have been used in 2013 to clean the RO plant.

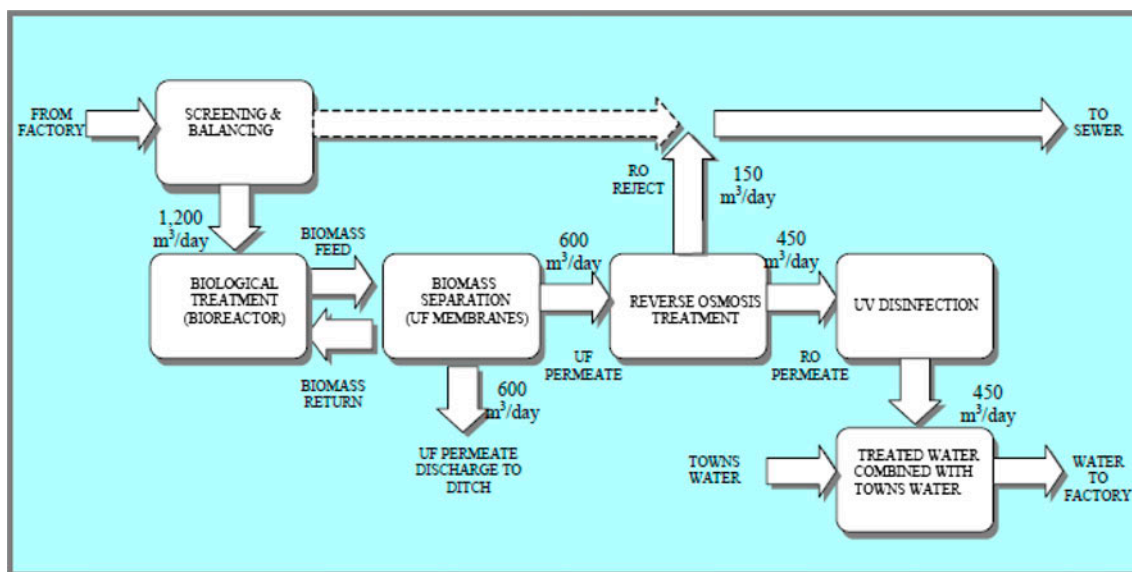

Fig. 5. Process flow diagram.

Product	Description	Mode of use
Cleaner A	Powder acidic high ionic strength detergent chelant surfactant cleaner with effervescents	1–2% solution 20–25°C pH 2.5–4
Cleaner B	Powder alkaline high ionic strength detergent chelant surfactant cleaner with effervescents	1–2% solution 35–40°C pH 11–13
Cleaner C	Liquid mild acid cleaner	2–3% solution 20–25°C pH 2.5–4
Cleaner D	Liquid alkaline cleaner	2–3% solution 35–40°C pH 11–13

3.4. Methodology

The cleaning process using conventional cleaners C & D is outlined followed by cleaning process using new cleaners A & B and finally the installation of the air induction system and methodology for microbubble cleaning.

3.4.1. Conventional cleaning

An alkaline clean using Cleaner D is conducted first to remove clay, organics and biofilm. This is then followed by an acidic clean using cleaner C to remove calcium carbonate and phosphate scale and metal oxides and hydroxides. The total CIP volume recommended by membrane manufacturers is 40 L per 8'' membrane element for each individual skid being cleaned. In order to prepare membranes for most efficient cleaning, heat CIP tank with just permeate to 35°C and circulate around membranes for 10–15 min to heat up the membrane elements. Prepare CIP solution with 3% Cleaner D and stabilise pH to 11.5 and heat to 35–40°C. Circulate the mixed, preheated cleaning solution to the vessel at low flow (3–4.5 m³/h per pressure vessel) and low pressure (2–2.5 bar low enough to prevent permeate being produced) to displace the process water. Measure pH and adjust if necessary, maintain temperature and recycle around the system for 20–30 min. If the solution shows any sign of significant discolouration, then discard and prepare fresh as per above to prevent possible membrane abrasion. Once the pH, temperature and colour have stabilised, allow to soak for as long as possible: ideally 4–6 h. For difficult fouling, an extended soaking period may be required—overnight; for example, high-flow pumping. Feed the cleaning solution at high

flow rates (9 m³/h at 3.5–4.0 bar) for 30–60 min. The high flow rate flushes out the foulants removed from the membrane surface by the cleaning. Finally, flush with good quality permeate to natural pH levels. The above process is the repeated with the acidic CIP solution prepared using 3% of Cleaner C, stabilising pH to 3.5–3.7, and heating cleaning solution to 25–30°C (at higher temperatures, calcium carbonate saturation will decrease causing potential deposition). The rest of the process is identical to that above. The whole procedure would normally take 6–8 h.

3.4.2. New cleaners A & B

The same process as described above was used when applying new cleaners A acidic and B alkaline. These cleaners are high ionic strength powders containing detergents, surfactants and chelants combined with effervescing agents to give multiple mechanisms for cleaning as explained earlier. Because they are powders, only 1% solution is required and they operate at the same pH as described for cleaners C & D. The cleaning process using the new cleaners took the same amount of time as previously 6–8 h. After some time, it was noted that the major fouling was in the first stage of the plant and due to organics, biofilm and clay, cleans were done only using alkaline cleaner B with very similar results. This cut the cleaning time down to 4–5 h.

3.4.3. New cleaner B plus microbubbles

In order to further enhance the cleaning effect, speed up the process and increase the periods between cleans, an air induction device was installed, which, in combination with the cleaning product B, produces a suspension of very small mini, midi and microbubbles between 5 and 500 μm in size. The microbubble generator device is installed on a bypass loop of the CIP system after the recirculating pump and cartridge filters on the inlet to the pressure vessels as shown in Fig. 6. Initially, a similar cleaning procedure was followed to that described above but the timescales for recirculation and soaking were reduced substantially following findings in the laboratory and on our test plant. The procedure has been fine tuned to a 20-min warm water flush, 20 min recirculation of 1% cleaning solution warmed to 35–40°C followed by a 20-min soaking period during which permeate flows back across the membrane due to normal osmosis lifting deposits from the feed-side membrane surface. The microbubble generator is then put online by partially opening valves 2, 3 and 4 and partially opening valve 1. The cleaning solution is then circulated for 20 min with

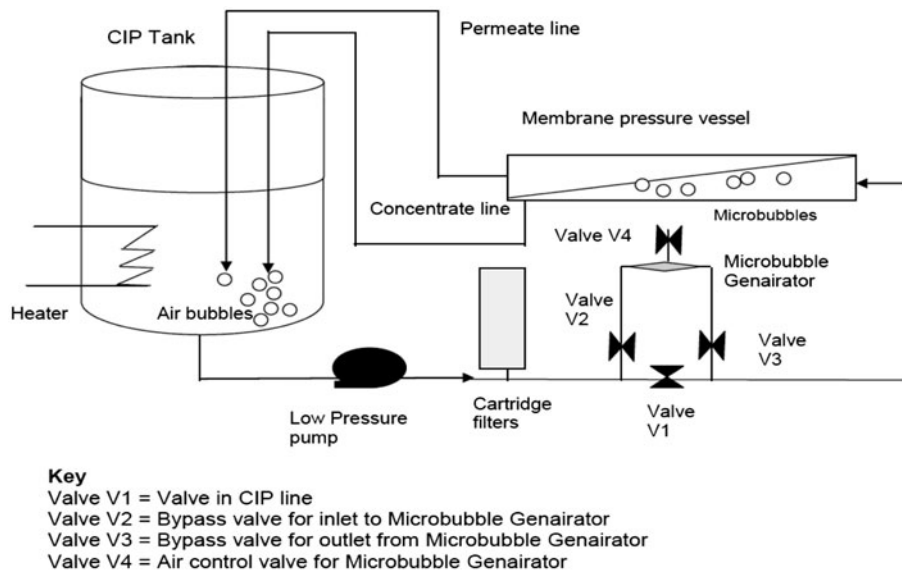

Fig. 6. Installation schematic for the CIP microbubble generator.

microbubbles to dislodge the cake layer on the membrane surface. The recirculation, soaking and microbubble stages are repeated twice maintaining the cleaning solution temperature at 35–40°C and pH between 11.5 and 12.0, followed by flushing with permeate. This procedure is carried out using alkaline Cleaner B only, and the whole cleaning process now only takes 2 h and 40 min.

4. Results

The graph in Fig. 7 shows the reduction in normalised differential pressure on stage 1 of the RO plant. From January 2013 to 1 June 2013, conventional cleans using cleaner C & D were carried out. Permeate production and normalised differential pressure (ndP) were temporarily restored but rapid refouling occurred. Cleans were conducted every 10.5 d on

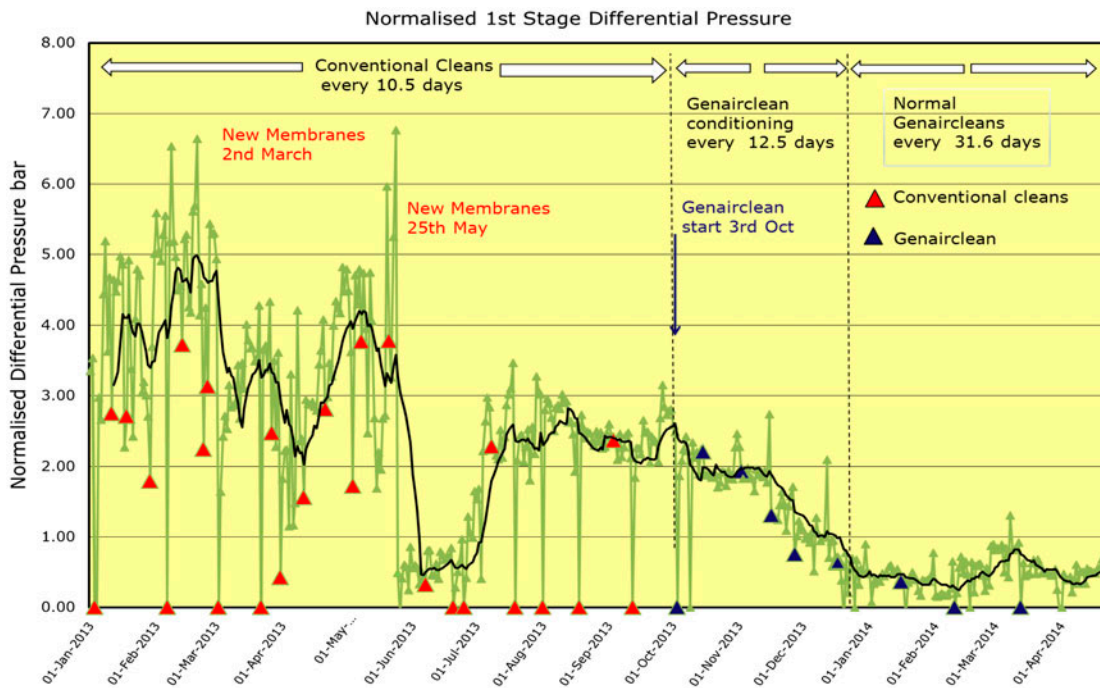

Fig. 7. Graph of normalised differential pressure over time using different cleaning methods.

average over this period. On the 2 March, all 30 of the membrane elements, in five pressure vessels, were replaced. The ndP was initially recorded at 1.5 bar but rose rapidly to 2.5 bar the next day, and then to over 4 bar on the 22 March when a clean was conducted. The clean was not very successful as the plant had not been cleaned for 20 d, so cleans were repeated on the 26 March and 31 March. Regular 10-day cleans were reinstated but only after three months, the ndP was above 4 bar, so it was decided to install a new set of membrane elements and change the cleaning reagent to Cleaners A & B. The first clean was conducted 7 d after installation and because ndP was low, the period between cleans was extended to 13 d. After one month of operation with new membranes, the ndP had increased but stabilised at 2.5 bar using cleaners A & B with additional effervescent and high ionic strength. This was a significant improvement on using the conventional cleaners C & D; however, fouling was still rapid and cleans were conducted every 11–13 d. On the 3 October, the air induction combined with Cleaner B to produce microbubbles was started. After three cleans, a significant improvement in ndP was observed with a cleaning frequency of 12.5 d on average. After three months and six cleans, the ndP had been reduced from 4.5 bar at the beginning of the year to consistently less than 1 bar on the first stage and on the whole plant. From January to April 2014, the frequency of cleans has been extended from every 10.5–31.6 d and latterly, the period between cleans has increased to over 50 d. The reason for the sudden increases in dP is thought to be due to the presence of biofilm and clay, which was only partially removed using conventional cleaners C & D. Cleaners A & B worked more effectively getting the membrane surface cleaner. When inducted air and cleaner B, to create microbubbles, were used, the membranes were significantly cleaner, reducing surface roughness, and hence the underlying fouling rate is much slower. Furthermore, it is thought that biofilm removal and disruption will significantly reduce the surviving microbial population which will not then replicate at the same rate despite the on-going nutrient source. The initial results are very encouraging showing a distinct improvement in the ability to clean these rapidly fouling membranes in a significantly shorter timescale. No loss of salt rejection has been detected and permeate flow has improved from 15 m³/h at the beginning of 2013 to 24 m³/h from January to April 2014.

5. Conclusions

The results of this study show encouraging results that, by combining multiple new cleaning mechanisms,

enhanced membrane deposit removal can be achieved offline thus prolonging membrane life and improving operational efficiency. A summary of our findings are:

- Cleaning is improved in the first stage of a rapidly fouling RO plant using a high ionic strength formulated cleaner with an effervescent reagent Cleaner B.
- Cleaning is further improved using microbubbles generated by a venturi air injector.
- The combined effect of cleaning with high ionic strength, effervescent cleaning reagents and microbubbles can significantly improve cleaning performance over conventional methods.
- The microbubble generator used in conjunction with Cleaner B produces a pulsed stream of very small bubbles which are more effective at cleaning than larger bubbles.
- Cleaning time can be reduced using this method.
- This concept can be easily and cost effectively applied to any RO/NF cleaning system.
- Reduction in feed pressure and differential pressure can give considerable pumping cost savings.

The work conducted in our laboratory and pilot plant is now being applied to operational plants, and subsequent case studies will be presented demonstrating the cost savings associated with this new cleaning technique.

References

- [1] W.S. Ang, N.Y. Yip, A. Tiraferri, M. Elimelech, Chemical cleaning of RO membranes fouled by wastewater effluent: Achieving higher efficiency with dual-step cleaning, *J. Membr. Sci.* 382 (2011) 100–106.
- [2] R. Wilson, M. Fazel, S. Chesters, Air bubbles enhance membrane cleaning: A future perspective, *The International Desalination Association (IDA) World Congress on Desalination and Water Reuse, Tianjin*, REF: IDAWC/TIAN13-225.
- [3] M. Fazel, S. Chesters, R. Wilson, Autopsy results confirm safe and effective use of microbubbles for removal of RO membrane scaling and fouling, *The International Desalination Association (IDA) World Congress on Desalination and Water Reuse, Tianjin*, REF: IDAWC/TIAN13-140.
- [4] S. Chesters, M. Fazel, M. Armstrong, RO membrane cleaning, past, present, future—Innovations for improving RO plant operating efficiency, *The International Desalination Association (IDA) World Congress on Desalination and Water Reuse, Tianjin*, REF: IDAWC/TIAN13-204.

- [5] N. Al-Bastaki, A. Abbas, Use of fluid instabilities to enhance membrane performance: A review, *Desalination* 136 (2001) 255–262.
- [6] A. Agarwal, H. Xu, W.J. Ng, Y. Liu, Biofilm detachment by self-collapsing air microbubbles, *J. Mater. Chem.* 2012(22) (2011) 2203–2207.
- [7] H. Choi, K. Zhang, D.D. Dionysiou, D.B. Oerther, G.A. Sorial, Effect of permeate flux and tangential flow on membrane fouling for wastewater treatment, *Sep. Purif. Technol.* 45 (2005) 68–78.
- [8] M.J. Um, S.H. Yoon, C.H. Lee, K.Y. Chung, J.J. Kim, Flux enhancement with gas injection in crossflow ultrafiltration of oily wastewater, *Water Res.* 35(17) (2001) 4095–4101.
- [9] P. Willems, A.J.B. Kemperman, R.G.H. Lammertink, M. Wessling, M. van Sint Annaland, N.G. Deen, J.A.M. Kuipers, W.G.J. van der Meer, Bubbles in spacers: Direct observation of bubble behavior in spacer filled membrane channels. *J. Membr. Sci.* 333 (2009) 38–44.